

\* All images are for illustrative purposes only.



reddot winner 2020



**LG LED** Bloc LSA Series

# True Innovation Behind Simplicity



Optimum Cable-less Installation



Alpha 7 Intelligent Processor



Dedicated Accessories



Meeting Room Solution Compatibility

## OPTIMUM CABLE-LESS DESIGN FOR SIMPLE INSTALLATION

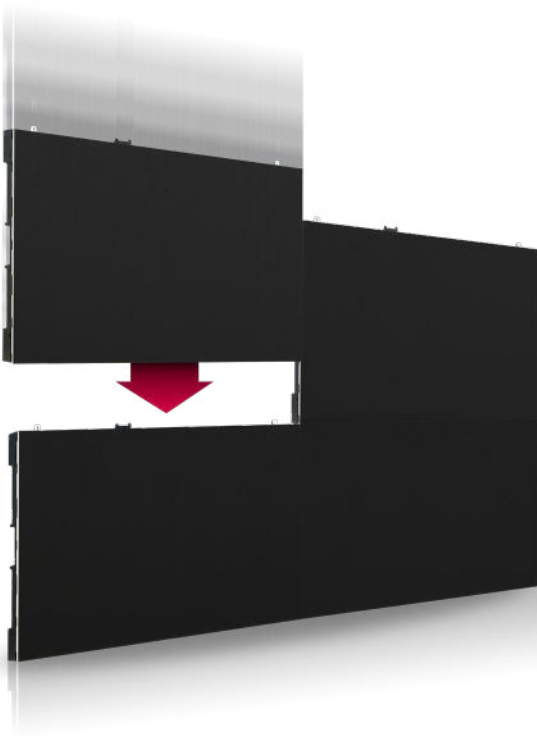

The LSAA series is the innovative LED signage applying the cableless transmission technology with non connectors\*. For up to UHD resolution with the 16:9 ratio, it does not require a cable connection between the cabinets to supply signal & power. Its block assembly design makes the LSAA series easier to be installed than before.

\* Non Connectors: Connectors that use RF (Radio Frequency) to transmit and receive data between two devices.

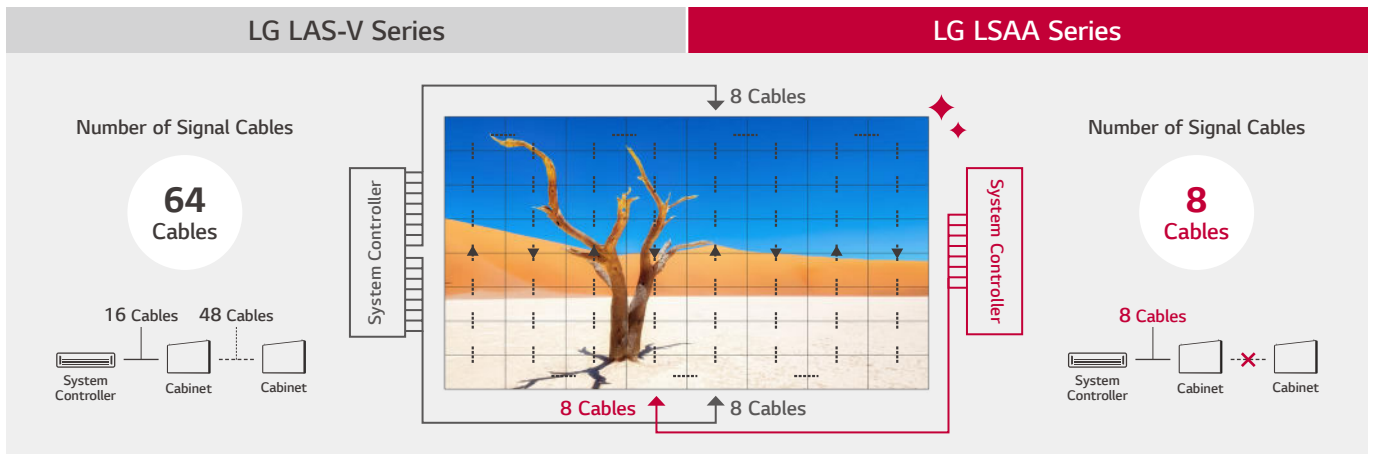
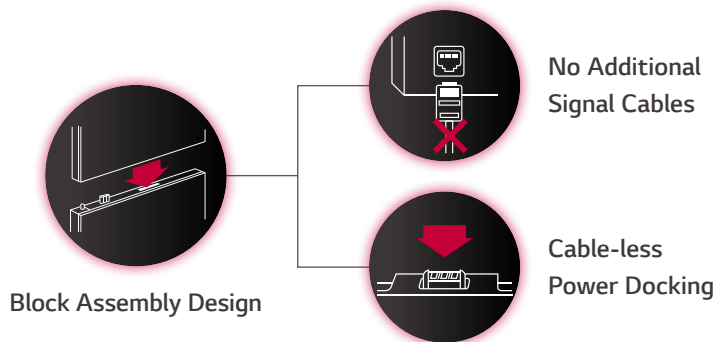

\* Based on P1.2, 16:9, UHD Resolution (8 x 8 Cabinets)

# Cable-less Signal Transmission & Power Docking



## POWERFUL PICTURE QUALITY

Alpha 7 Intelligent Processor



### Optimized Image Quality with α 7 Intelligent Processor

The "Alpha 7 Intelligent Processor" applied to the LSAA series recognizes and analyzes the original content, optimizing the clarity and sharpness of the content for itself.

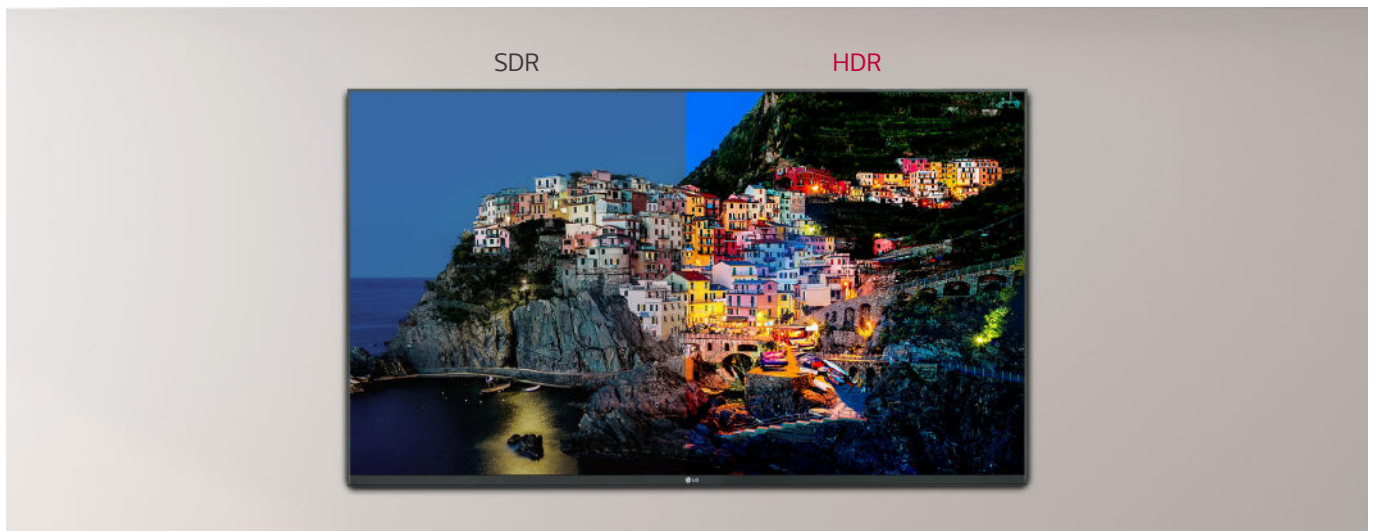

### Vivid Color Expression Powered by HDR

With HDR (HDR10, HDR10 Pro\*) support, content becomes vivid with great visual impact. The wider color spectrum and greater contrast ratio allow viewers to fully enjoy lively content.

\* HDR10 Pro is LG's own HDR solution for processing HDR signal by using enhanced dynamic tone mapping.

## OPTIMUM LED DISPLAY FOR ENTERPRISE USAGE

### » Wall Mount Kit for Various Installation in Size

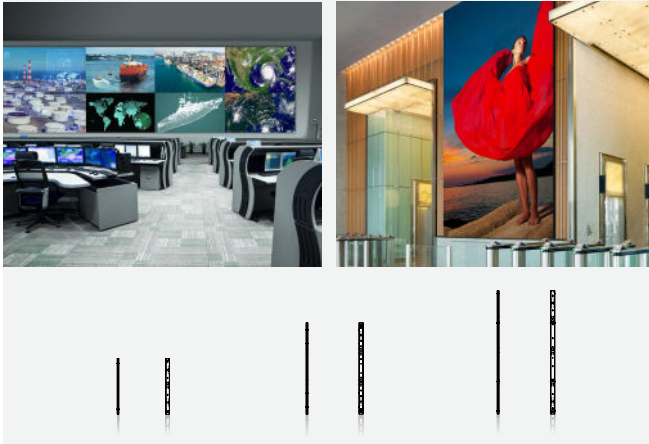

### » Frame Kit for 16:9 Installation in FHD / UHD Resolution

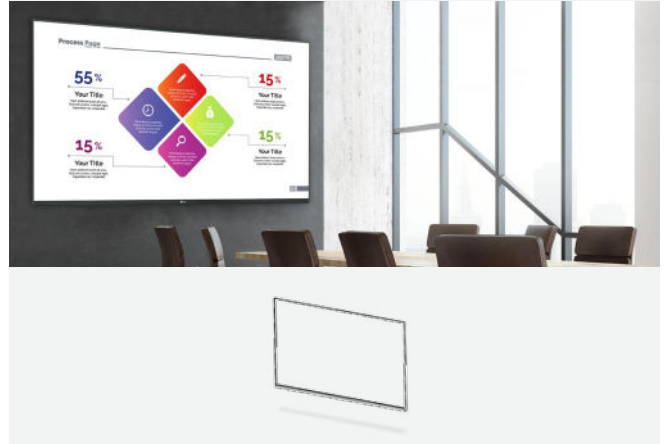

## Dedicated Accessories Available

The screen size can be easily expanded as desired using the dedicated wall mount kits. In addition, LG offers two types of frame kits for cabinet 4 × 4 (108") and 6 × 6 (163").

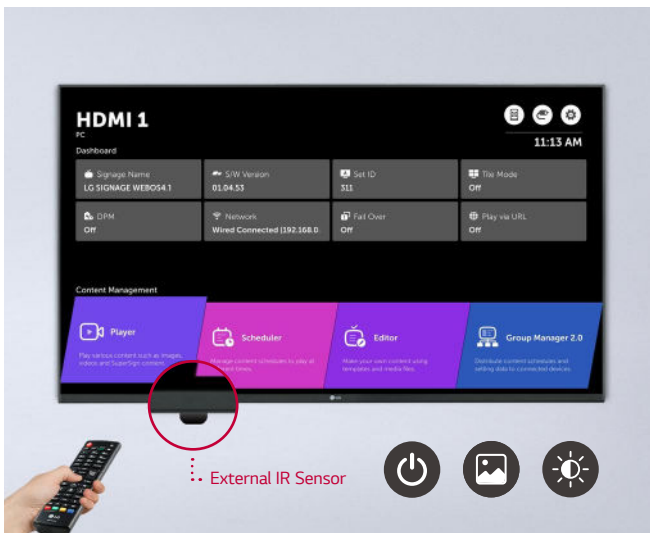

## Easy Remote Control Support

The LSAA series allows users to easily access the settings, such as Picture Mode, volume, etc. by using a remote control instead of connecting to a PC. It uses the same UI as general LG digital signage, so users can easily adapt to it.

\* The easy-viewing UI menu is available for over 1,280 × 720 resolution screens.



## Compatibility with AV Conference Systems

The LSAA series has been certified Crestron Connected® for a high level of compatibility with professional AV controls to achieve seamless integration and automated control\*, boosting business management efficiency.

\* Network-based control

## DELICATE FEATURES CONSIDERING UP-CLOSE USE



### EMC Class B Certified

The LG LSAA series is certified as EMC Class B, which requires electronic equipment made for use in residential environments as well as commercial, industrial, or business environments. Therefore, it is suitable for up-close uses such as corporate meeting rooms, board rooms, etc.

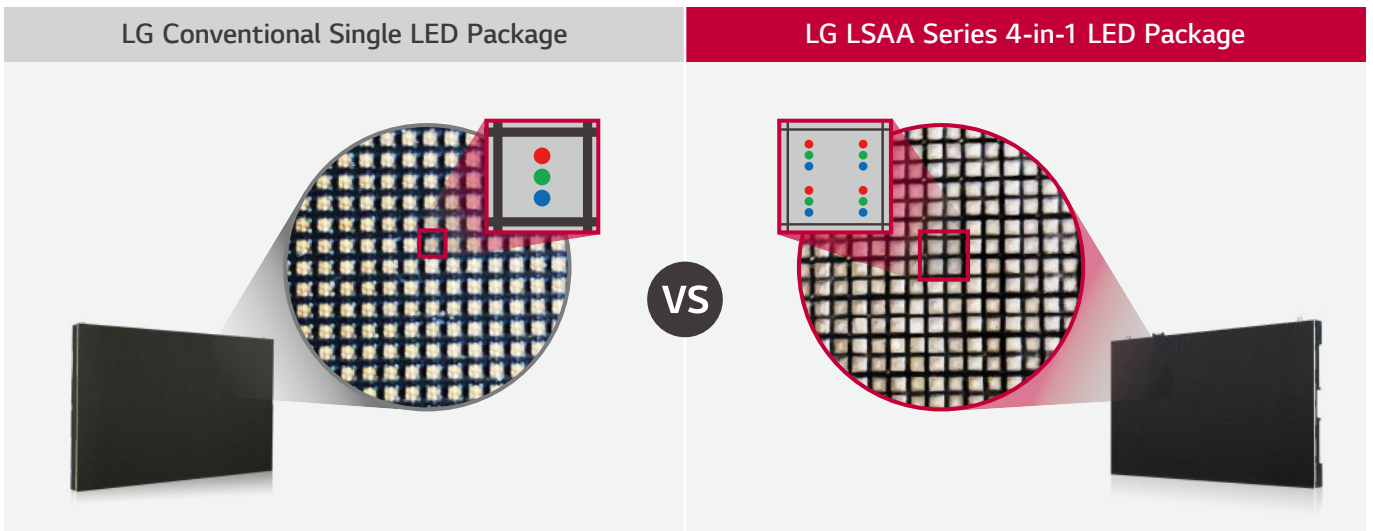

### 4-in-1 LED Package

By adopting a 4-in-1 LED package in which 4 pixels are combined and integrated into one single LED package, the LSAA series offers better LED module protection. It is more robust to human touch than the conventional LED display.

## ENHANCED POWER EFFICIENCY

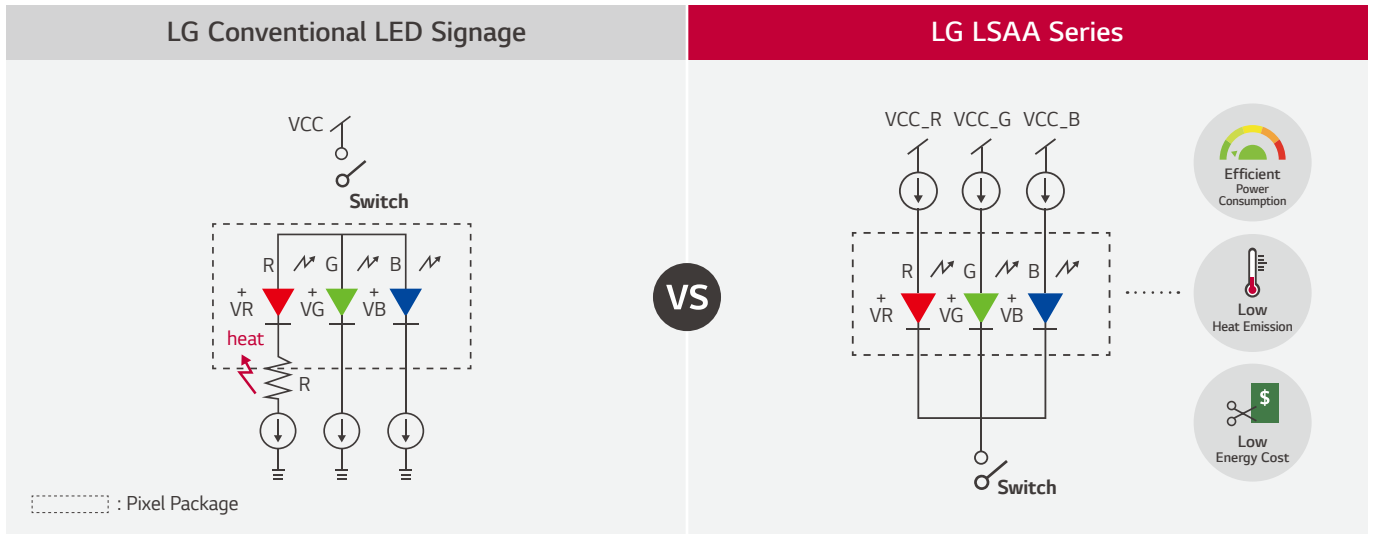

### Energy Saving Power System

By applying Common Cathode Drive-IC, LSAA series supplies the right necessary voltage to each R/G/B sub-pixel individually, ensuring efficient power consumption.

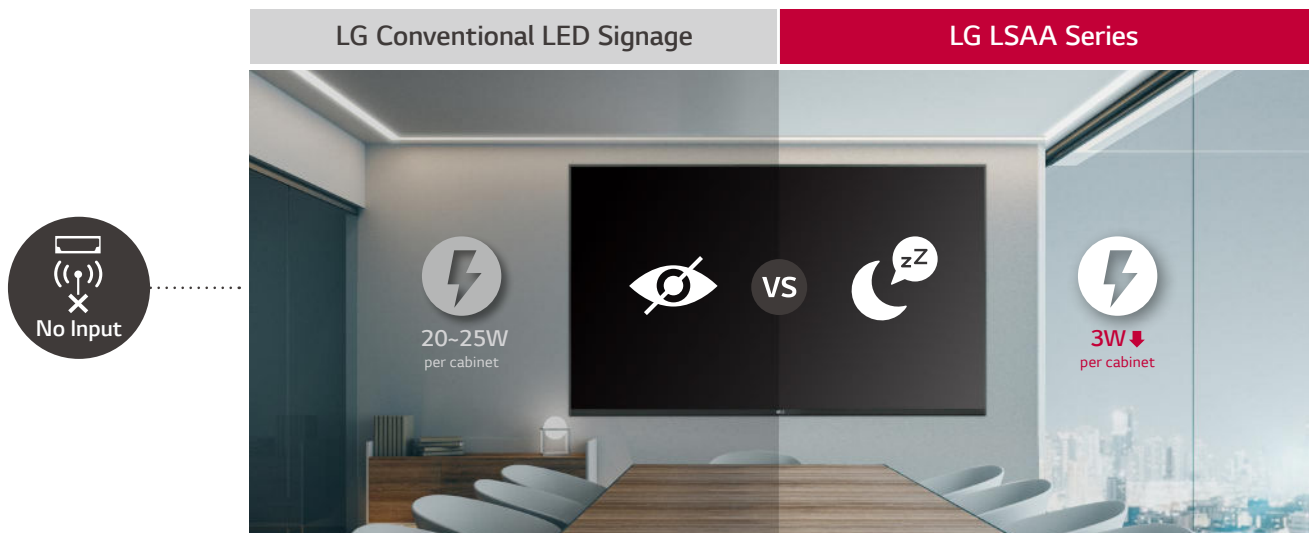

### Standby Mode

When there is no input signal for a period of time, the screen turns off and the main circuit parts inside the LED cabinet go to a standby mode. This saves additional power consumption and enables the product to be reactivated simply by using a remote control.

## DELICATE FEATURES FOR OPERATION AND MANAGEMENT



### Real-time ConnectedCare Service

Maintenance is easy and fast with the optional ConnectedCare\* service, a cloud service solution provided by LG. It remotely manages the status of displays in client workplaces for fault diagnosis and remote-control services, enabling the stable operation of clients' businesses.

\* ConnectedCare is the brand name of LG Signage365Care Service. The availability differs by region.

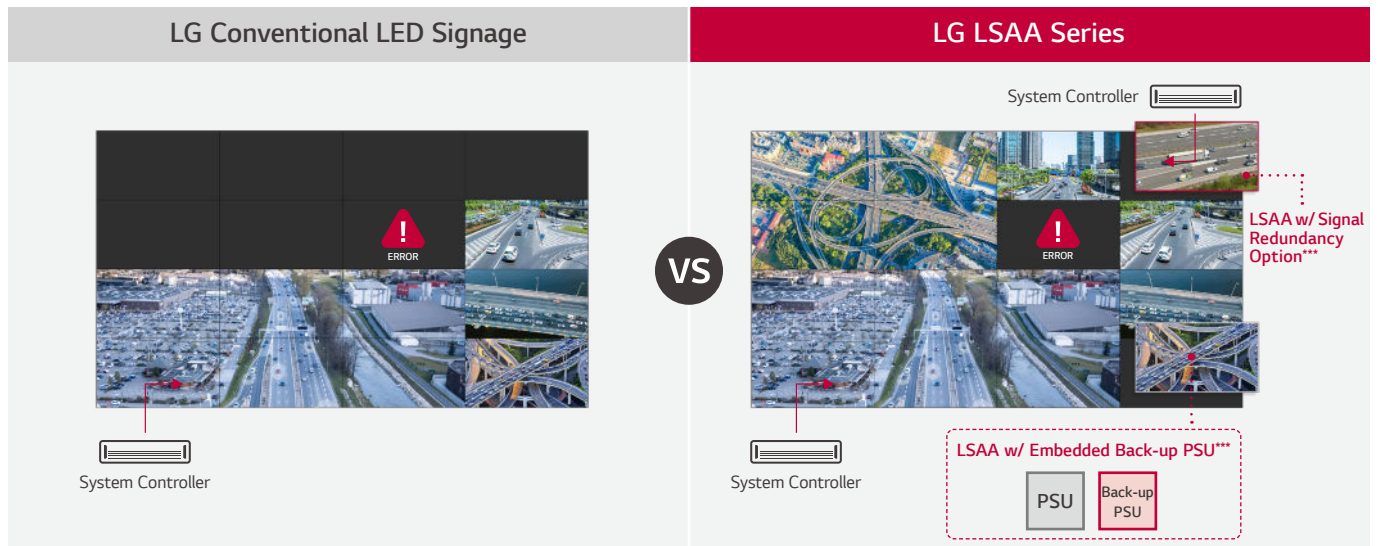

### Power/Signal Redundancy Support

The LSAA series is designed to support redundancy of signal and power, providing users with comfort. With optional embedded back-up power supply unit and signal redundancy, customers can assure the continuous operation of the screen without power failure, while the dual controllers minimize screen failure with a bi-directional signal input.

\* The "Conventional" shown above refers to LED displays which do not support the power/signal redundancy mode.

\*\* The power/signal redundancy features are available from the fourth quarter of 2020.

\*\*\* The power/signal redundancy models are optional.

# USAGE SCENES





## PRODUCT INFORMATION



# LG SuperSign

Cabinet	LSAA012-MX5/SX5	LSAA012-MX6/SX6
Pixel Configuration	4 in 1 SMD	4 in 1 SMD
Pixel Pitch (mm)	1.25	1.25
No. of Modules per Cabinet (W x H)	2 x 3	2 x 3
Cabinet Resolution (W x H)	480 x 270	480 x 270
Cabinet Dimensions (W x H x D, mm)	600 x 337.5 x 44.9	600 x 337.5 x 44.9
Max Brightness (After Calibration, nit)	600 / 1,200 (Peak)	600 / 1,200 (Peak)
Contrast Ratio	5,000 : 1, 8,000 : 1 (Peak)	5,000 : 1, 8,000 : 1 (Peak)



# webOS

System Controller	CSAA-012X
Loading Capacity	3,840 x 2,160 @ 60Hz
Input	HDMI 2.0, HDCP 2.2, DP 1.2 / HDCP 2.2
Output	Ethernet (8-channel)
Control	LAN, RS-232C (LOOP)
HDR Compatibility	HDR10 Pro
Dimension (W x H x D, mm)	443 x 63 x 298

## DIMENSION (unit: mm)

### CABINET

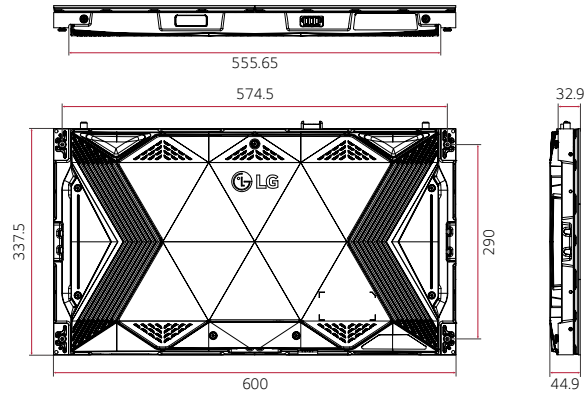

### SYSTEM CONTROLLER

CSAA-012X

CSAA-015X2

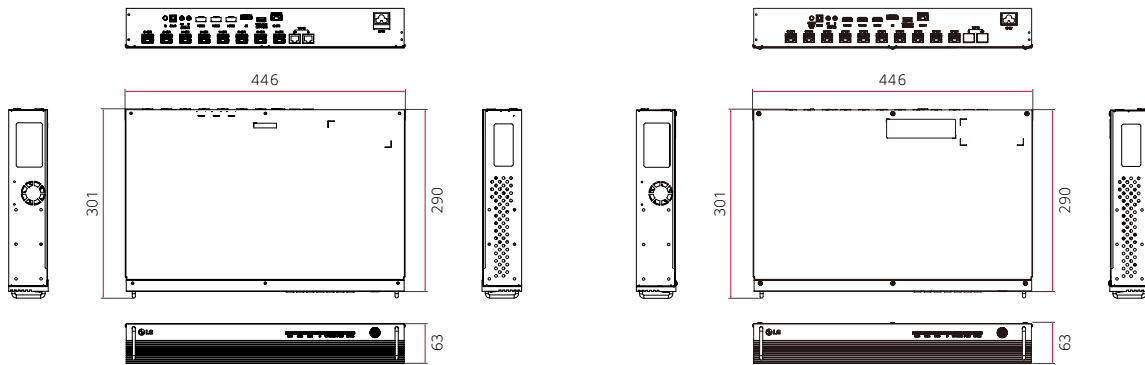

## CONNECTIVITY

### SYSTEM CONTROLLER

CSAA-012X

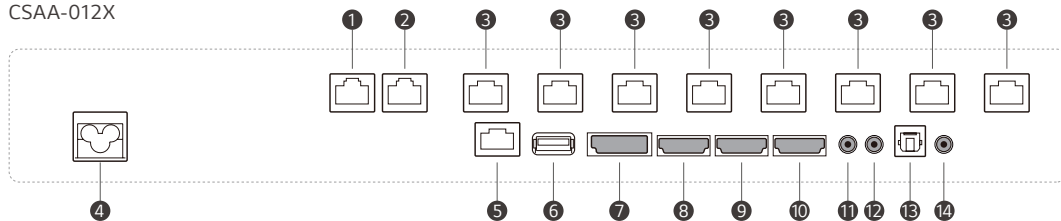

CSAA-015X2

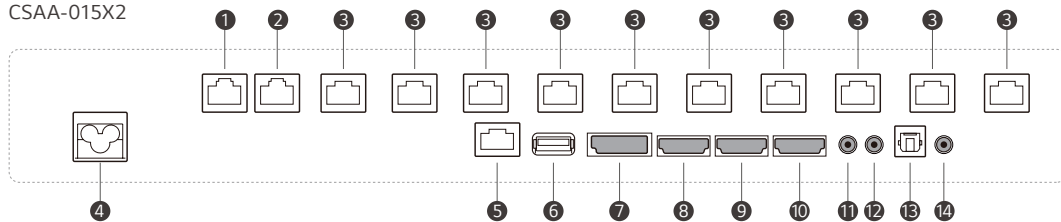

- 1 IR-APL OUT
- 2 IR-APL IN
- 3 Ethernet (5 Gbps)
- 4 AC-IN
- 5 LAN IN
- 6 USB 2.0 IN
- 7 DP
- 8 HDMI 1
- 9 HDMI 2
- 10 HDMI 3
- 11 RS-232C IN
- 12 RS-232C OUT
- 13 OPTIC
- 14 IR



\* Dimensions & Jack Panels may differ from the above image, so please contact LG sales team to verify before ordering.

# SPECIFICATIONS

Panel	Model Name	LSAA012-MX5/SX5	LSAA012-MX6/SX6
Physical Parameters	Pixel Configuration	4 in 1 SMD	4 in 1 SMD
	Pixel Pitch (mm)	1.25	1.25
	Module Resolution (W × H)	240 × 90	240 × 90
	Module Dimensions (W × H, mm)	300 × 112.5	300 × 112.5
	Weight per Module (kg)	0.20	0.20
	No. of Modules per Cabinet (W × H)	2 × 3	2 × 3
	Cabinet Resolution (W × H)	480 × 270	480 × 270
	Cabinet Dimensions (W × H × D, mm)	600 × 337.5 × 44.9	600 × 337.5 × 44.9
	Cabinet Surface Area (m <sup>2</sup> )	0.203	0.203
	Weight per Cabinet (kg/Cabinet)	7.3	7.3
	Weight per Square Meter (kg/m <sup>2</sup> )	36.1	36.1
	Physical Pixel Density (pixels/m <sup>2</sup> )	640,000	640,000
	Flatness of Cabinet (mm)	±0.5	±0.5
	Cabinet Material	Extrusion Aluminum	Extrusion Aluminum
Service Access	Front and Rear <sup>1)</sup>	Front and Rear <sup>1)</sup>	
Optical Specifications	Brightness (After Calibration, nit)	600 / 1,200 (Peak)	600 / 1,200 (Peak)
	Color Temperature (K)	3,200-9,300 (Default 6,500) <sup>2)</sup>	3,200-9,300 (Default 6,500) <sup>2)</sup>
	Visual Viewing Angle (H × V)	170 × 170	170 × 170
	Brightness Uniformity	95%	95%
	Color Uniformity	±0.015 Cx, Cy	±0.015 Cx, Cy
	Contrast Ratio	5,000 : 1 / 8,000 : 1 (Peak)	5,000 : 1 / 8,000 : 1 (Peak)
Electrical Specifications	Processing Depth (bit)	20 (HDR10, HDR10 Pro) <sup>3)</sup>	20 (HDR10, HDR10 Pro) <sup>3)</sup>
	Power Consumption (W/Cabinet, Max.)	75	68
	Power Consumption (W/Cabinet, Avg.)	52	52
	Power Consumption (W/m <sup>2</sup> , Max.)	370	332
	Heat Dissipation (BTU/h/Cabinet, Max.)	256	232
	Heat Dissipation (BTU/h/Cabinet, Avg.)	177	177
	Heat Dissipation (BTU/h/m <sup>2</sup> , Max.)	1,263	1,133
	Power Supply (V)	100 to 240	100 to 240
Operation Specifications	Frame Rate (Hz)	50 / 60	50 / 60
	Refresh Rate (Hz)	3,840	3,840
	LED Lifetime (Half brightness)	100,000	100,000
	Operating Temperature (°C)	0 to +40	0 to +40
Environment	Operating Humidity	10-80% RH	10-80% RH
	IP Rating Front / Rear	IP20 / IP20	IP20 / IP20
Certification	Safety 60950-1, EMC Class B, BS476 Part7 Class1	Safety 60950-1, EMC Class B, BS476 Part7 Class1	
Environment	RoHS	RoHS	
Controller	CSAA-012X5	CSAA-012X5	
90 Degree Corner Cut	No	No	

<sup>1)</sup> Module can be accessed only from the front.

<sup>2)</sup> Adjustable via LED Assistant on PC

<sup>3)</sup> LG's own HDR solution to process HDR signal by using enhanced dynamic tone mapping.

Controller	Model Name	CSAA-012X
	Cabinet	LSAA012-MX/SX
Max Output Range	Loading Capacity	3,840 × 2,160 @ 60Hz
	Output Resolution	8,2944 Million Pixels
Input	HDMI	HDMI 2.0
	HDCP	HDCP 2.2
	DP	DP 1.2 / HDCP 2.2
Output	Ethernet (To LED Screen)	Yes (8-channel)
Control	LAN	Yes
	RS-232C	Yes (LOOP)
Sensor	Ambient Light	Yes
	Temperature	Yes
Video Processing	Brightness Adjustment	Yes
	Chroma Adjustment	Yes
	Improved Grayscale at Low Brightness	Yes
	Scaling	Yes
	HDR	HDR10 Pro
Application	CMS	SuperSign CMS
	webOS API	Yes
	LG ConnectedCare	Yes
	Configuration SW	LED Assistant
Mechanical	Size (W × H × D, mm)	446 × 63 × 298
	Weight (kg)	4.5

\* Specifications are subject to change without notice. Please make sure to check the product manual for details about product usage.



Download  
LG C-Display+  
Mobile App  
Google Play Store

[www.lg.com/global/business/information-display](http://www.lg.com/global/business/information-display)  
[www.youtube.com/c/LGCommercialDisplay](https://www.youtube.com/c/LGCommercialDisplay)  
[www.facebook.com/LGInformationDisplay](https://www.facebook.com/LGInformationDisplay)  
[www.linkedin.com/company/lginformationdisplay](https://www.linkedin.com/company/lginformationdisplay)  
[twitter.com/LG\\_ID\\_HQ](https://twitter.com/LG_ID_HQ)

LG may make changes to specifications and product descriptions without notice. Copyright © 2022 LG Electronics Inc. All rights reserved. "LG Life's Good" is a registered trademark of LG Corp. The names of products and brands mentioned here may be the trademarks of their respective owners.

