

EPDS

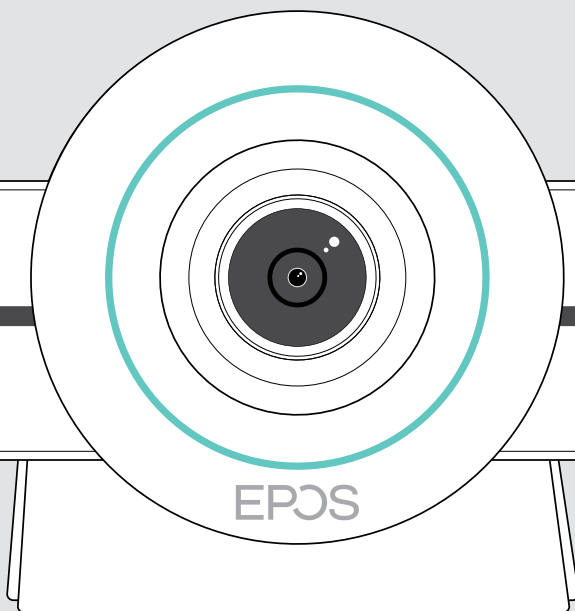

EXPAND VISION 3T

Video collaboration bar for Microsoft® Teams

User Guide

Contents

Welcome	3
Package contents	4
EXPAND VISION 3T at a glance	6
Video collaboration bar at a glance.....	6
Remote control at a glance	8
Speakerphone at a glance.....	10
Placing/mounting EXPAND VISION 3T	12
Installation options	12
A Placing the product on a desk.....	13
B Placing the product on a screen / monitor.....	13
C Mounting the product on a wall.....	14
Connecting / preparing devices	15
Connection possibilities.....	15
1 Connecting a screen.....	17
2 Connecting to a network.....	18
3 Connecting the speakerphone	19
4 Connecting to the power supply	20
5 Inserting the remote batteries.....	21
Pairing Bluetooth devices	22
Connecting other accessories	23
Using EXPAND Vision 3T in USB-mode (BYOD).....	24
Positioning the devices.....	25
How to use – the basics.....	26
Adjusting the camera.....	26
Changing the volume	27
Muting / unmuting the microphone.....	28
Joining meetings / calls.....	28

Good to know.....	29
Mirroring the screen.....	29
Using an optional Kensington® lock.....	29
Standby mode & waking up.....	30
Using the privacy buttons.....	31
Changing EXPAND VISION 3T settings.....	32
Maintaining & updating products.....	33
Cleaning the products.....	33
Storing and carrying the speakerphone.....	33
Updating the firmware.....	34
Replacing / removing the batteries.....	34
If a problem occurs.....	35
Collaboration bar solutions.....	35
Speakerphone solutions.....	37
Pairing a new remote.....	38

Welcome

Video collaboration. Reinvented.

All-in-one video collaboration solution for today's smart office. Join meetings with just one touch and enjoy a full Microsoft Teams experience.

Empower your meeting room

Comes with wide angle 4K camera with Sony® sensor, enhanced PTZ and superior audio from included EPOS EXPAND SP 30T

Microsoft Teams certified

Immerse yourself in Microsoft Teams with all the familiar features. Fully integrated

Key benefits & features

Easy setup. Easy maintenance

Intelligent solution with automatic software updates, remote device management and provisioning. Simply plug and play

One-touch join

All-in-one solution that's ready when you are. No PC needed. One touch, and you're in

Like being there

Enjoy a natural meeting experience with intelligent picture framing, voice tracking and noise cancellation. Powered by EPOS AI™



For safety instructions, consult the Safety Guide.



For specifications, consult the Fact sheet available at eposaudio.com

Trademarks

The Bluetooth® word mark and logos are registered trademarks owned by Bluetooth SIG, Inc. and any use of such marks by DSEA A/S is under license.

The N-Mark is a trademark or registered trademark of NFC Forum, Inc. in the United States and in other countries.

USB Type-C® and USB-C® are trademarks of USB Implementers Forum.



Kensington is a registered trademark of ACCO Brands. Kensington The Professionals' Choice is a trademark of ACCO Brands.

All other trademarks are the property of their respective owners.

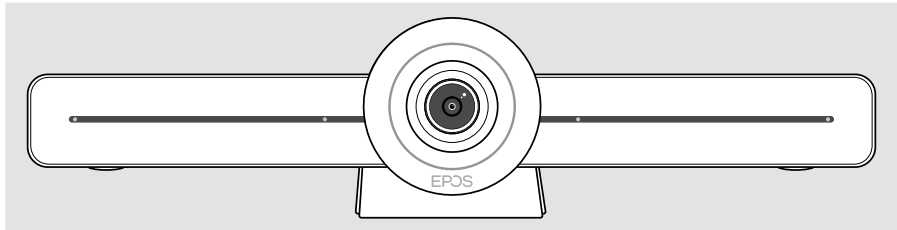
Package contents

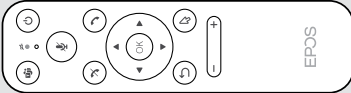
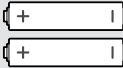
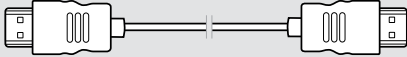
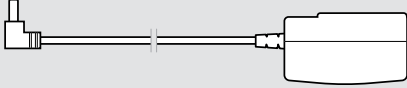
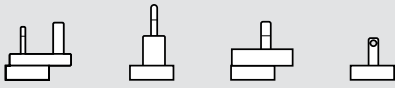
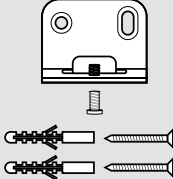

EXPAND VISION 3T Video collaboration bar

	<p>VISION-RC01T Remote control</p>
	<p>Batteries for remote control AAA Alkaline batteries</p>
	<p>HDMI cable</p>
	<p>Power supply unit</p>
	<p>Country adapters UK, EU, AU, US</p>
	<p>Wall mount accessories Mounting plate Affixing screw Dowels* Dowel screws</p> <p>*differing wall types may require specific dowels</p>
	<p>Quick Guide Safety Guide Compliance sheet</p>

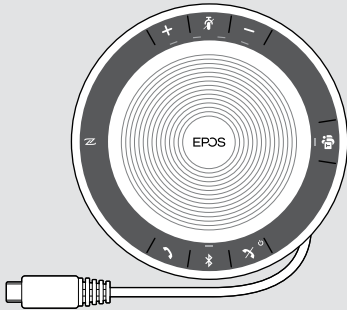

EXPAND SP 30T
Bluetooth® speakerphone
with built-in rechargeable battery

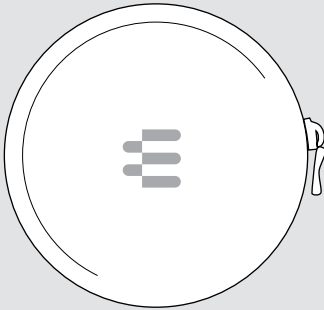

Carry pouch
for speakerphone

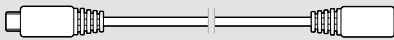

USB extension cable, 5 m

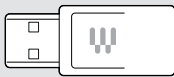

USB-C® to USB-A adapter

In this User Guide only the main functions of the EXPAND SP 30T are explained and focused on the collaboration bar connection.



For further connections and functionalities, check the full EXPAND SP 30T User Guide on the product page at eposaudio.com.

EXPAND VISION 3T at a glance

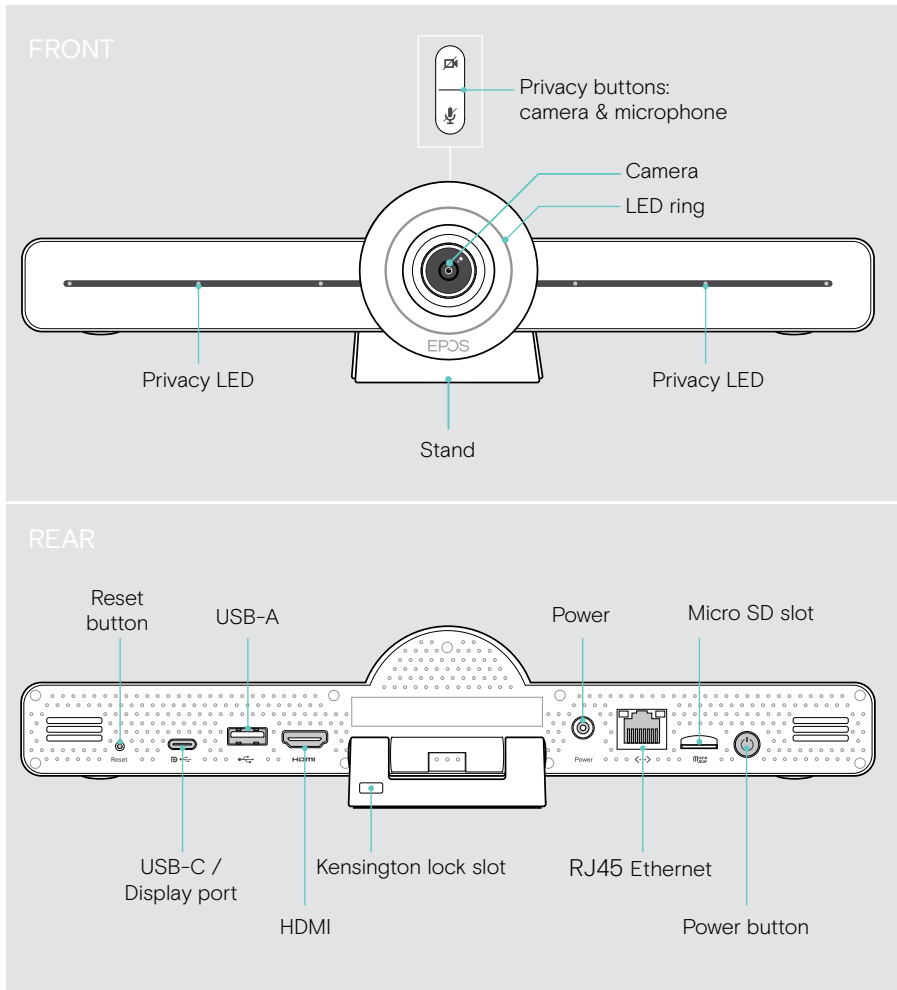











Video collaboration bar at a glance



Collaboration bar: LED at a glance

	Switched on		Standby mode
	Switched off / not connected to the mains		

During a meeting

		Camera active			Camera inactive
		Microphone unmuted			Microphone unmuted
		Camera active			Camera inactive
		Microphone muted			Microphone muted



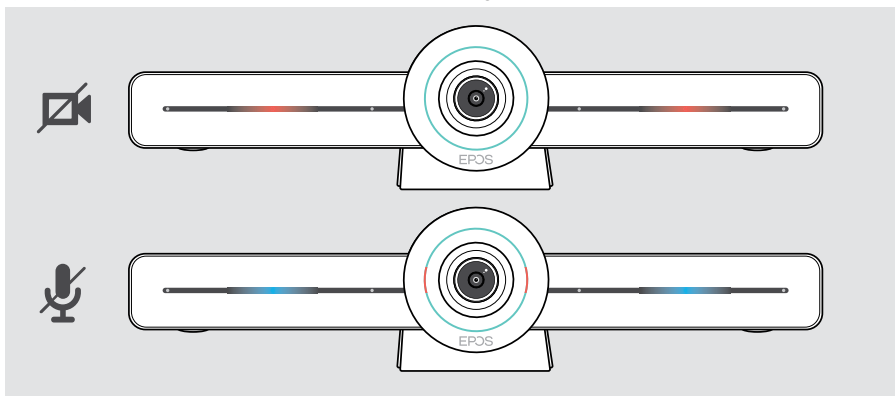



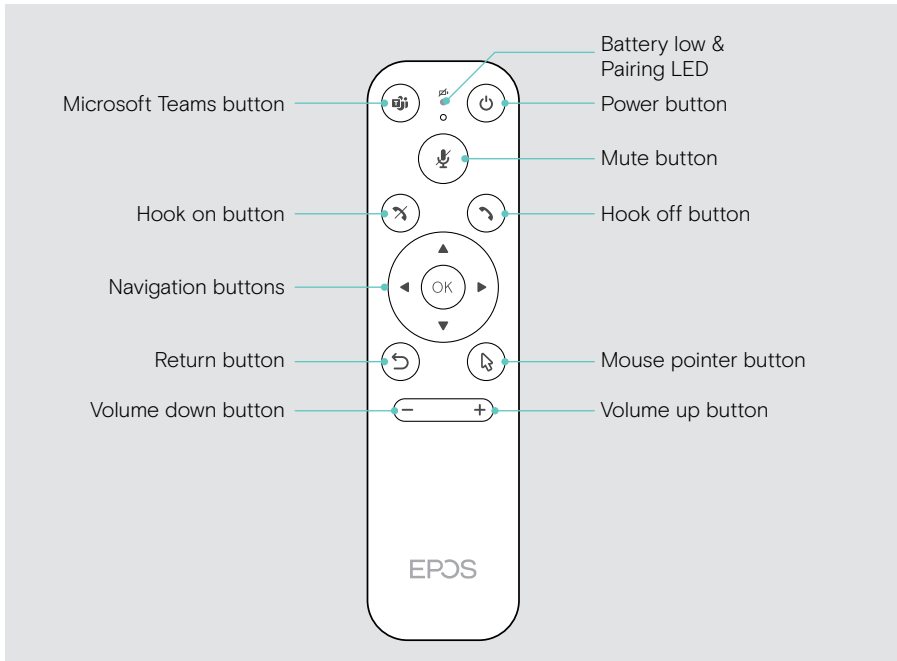

Privacy mode Camera / Microphone (see page 31)



Remote control at a glance

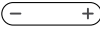

Remote control: Buttons at a glance

Button	Function	Page
Microsoft Teams	 Starts next Microsoft Teams meeting	-
Power	 Standby / Wake up	30
Mute	 Mutes / Unmutes the speakerphone's microphone	28
Hook on	 Ends / rejects a call	-
Hook off	 Accepts a call	-
Navigation	 <ul style="list-style-type: none"> • Arrows: Moves between different functions • OK: Selects the element where the mouse pointer is located 	-
Back	 Returns to previous menu	-
Mouse pointer	 Activates the mouse pointer	-
Volume down / up	 <ul style="list-style-type: none"> - Decreases the volume + Increases the volume 	27

Speakerphone at a glance

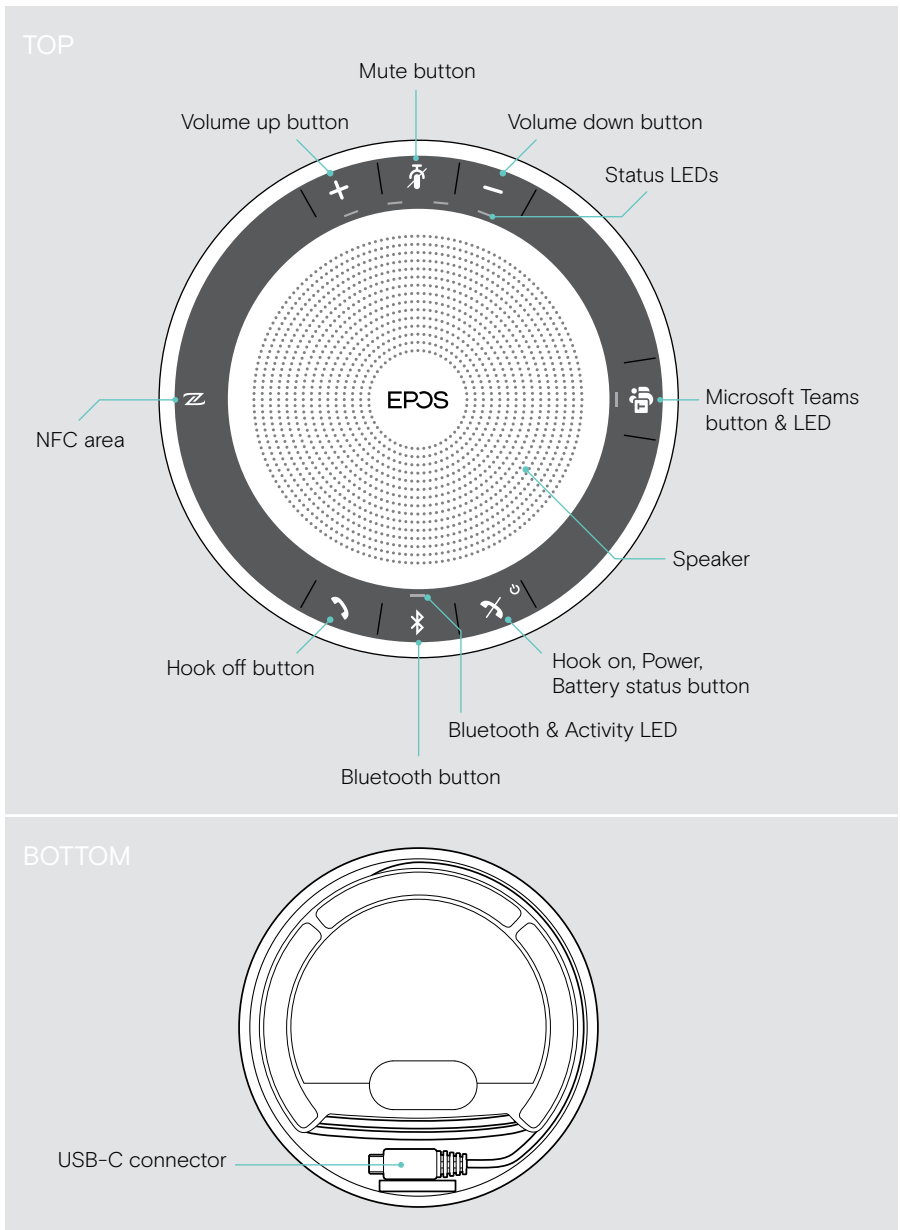

Speakerphone: LEDs at a glance

Activity LED



	Meaning
	Device switched on
3x	Device switching off
	Device switched off
	Incoming call
	Active call
	Call on hold
	Second call on hold

Status LEDs

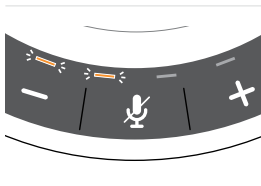

	Meaning
	Microphone muted
	Volume level; 8 steps
	Battery status; 8 steps

For further connections and functionalities, check the EXPAND SP 30T User Guide on the product page at eposaudio.com.

Placing/mounting EXPAND VISION 3T

Installation options

The collaboration bar can be:

- **A** placed on a desk
- **B** placed on top of a screen/monitor
- **C** mounted on a wall

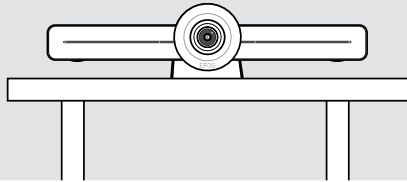
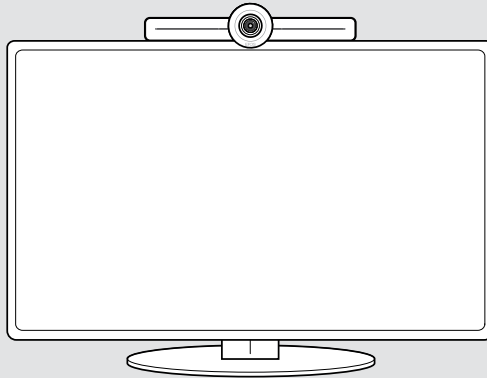
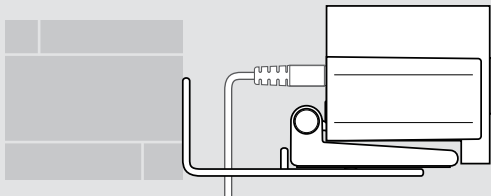
A**B****C**

A Placing the product on a desk

- > Place the collaboration bar on your desk.
- > Hold down the stand and rotate the collaboration bar so that it points in the direction of the meeting participants.

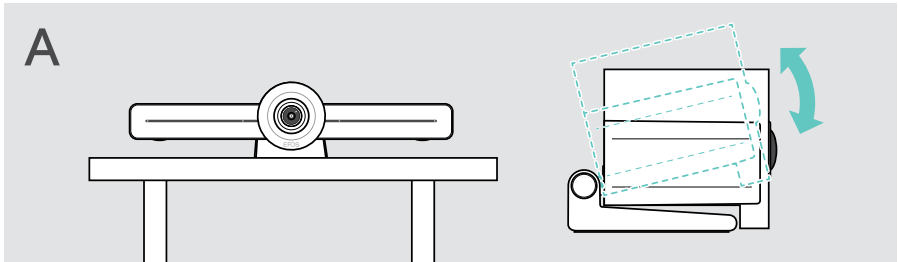

B Placing the product on a screen / monitor

- > Rotate the stand.
- > Put the product on the top of your screen/monitor.
- > Hold down the product and rotate the stand so that it is fixed securely on your device.

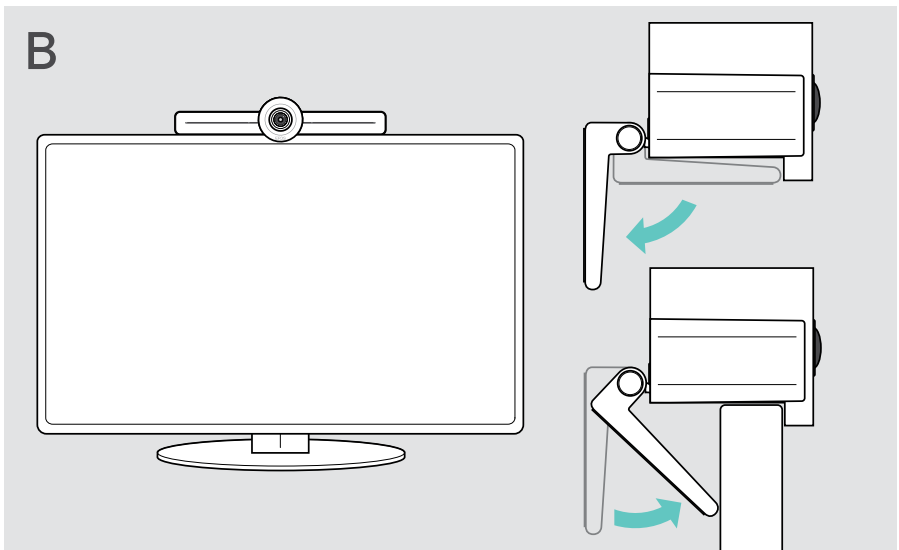

C Mounting the product on a wall



CAUTION

Danger of accidents or damages!

Drilling into e.g. cables and can lead to accidents.

> Check whether there are any cables or pipes in the wall.

The wall type is an example - other wall types may require different mounting.

- 1 Choose a position so that the **camera meets the eye-height of meeting participants**. Hold the mounting plate against the wall, balance it and add two marks.
- 2 Drill two holes.
- 3 Insert the two dowels.
- 4 Hold the mounting plate against the wall and fix it with the screws. Start on the left and bring it in balance with the other screw.
- 5 Hold the collaboration bar and connect the required cables as the space is small when finally mounted > see page 15.
- 6 Position the collaboration bar and tighten the screws.

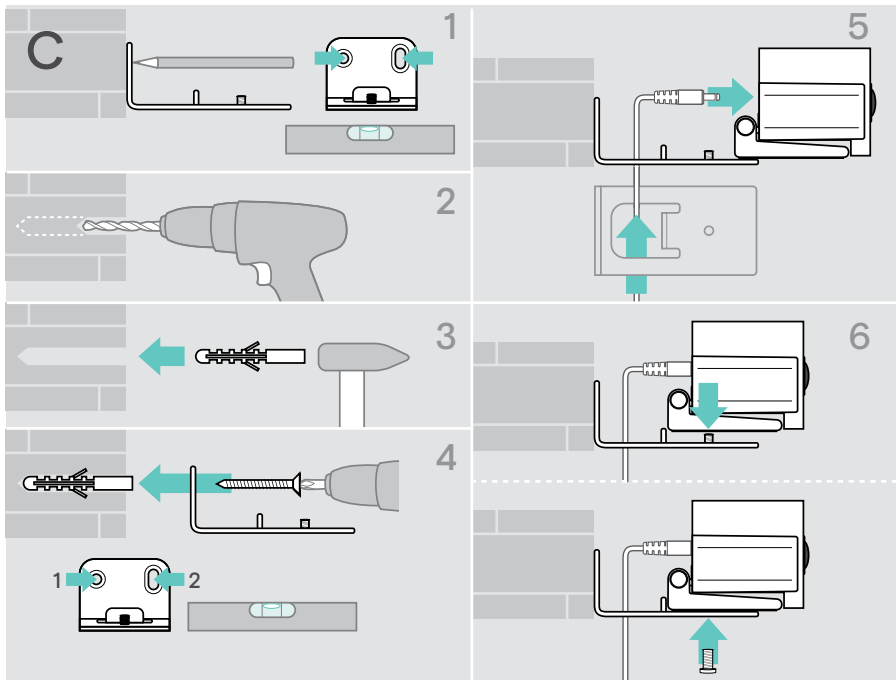

Connecting / preparing devices

Connection possibilities

The collaboration bar with its speakerphone works as an All-in-one solution. You only need a screen/monitor, internet access and a Microsoft Teams account.

Required connections & actions

Page

1	Screen / monitor	17
2	Network	18
3	Speakerphone	19
4	Power supply	20
5	Remote control batteries	21
If you want to work with a UC provider other than Microsoft Teams: You can use the product as a USB device.		24

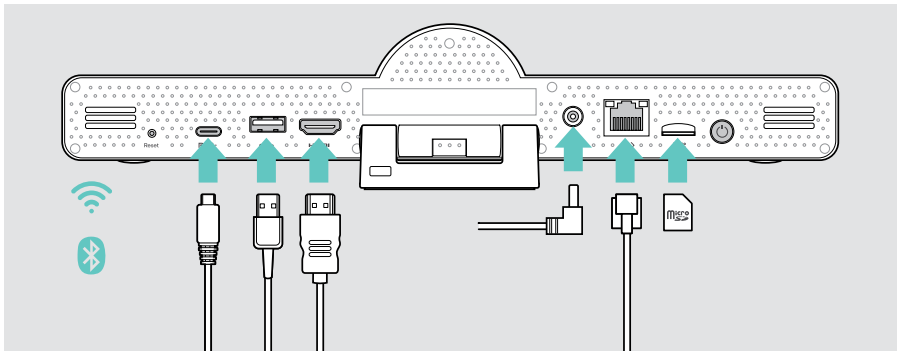

In addition to the listed devices you can connect a variety of different in- and output devices to the collaboration bar via the ports shown below.



For even more connection possibilities see EXPAND SP 30T User Guide.







Network options

Page

	Wi-Fi	18
 <...>	Ethernet	

Wired devices & memory card options

Page

 	USB-A:	19	
	• Speakerphone		23
	• Audio Device		
	• Keyboard / Mouse		23
	• Touch Screen interface		
 	USB-C / Display port:	19	
	• Speakerphone		24
	• Laptop: use it as USB device		
	• Audio Device	23	
	• Keyboard / Mouse		
	• Screen / Monitor	17	
 HDMI	HDMI Out:	17	
	• Screen / Monitor		
 microSD	Micro SD:	23	
	• Micro SD memory card: expansion of internal storage		

Bluetooth devices options

Page

	• Keyboard / Mouse	22
	• Audio Device	

1 Connecting a screen

You can connect one or two screens via:



HDMI: primary screen/monitor

- > Connect the delivered HDMI cable to the **HDMI OUT** and your screen/monitor.



USB-C / Display port: secondary screen/monitor

- > Connect a USB-C cable to the USB-C / Display port and your screen/monitor.

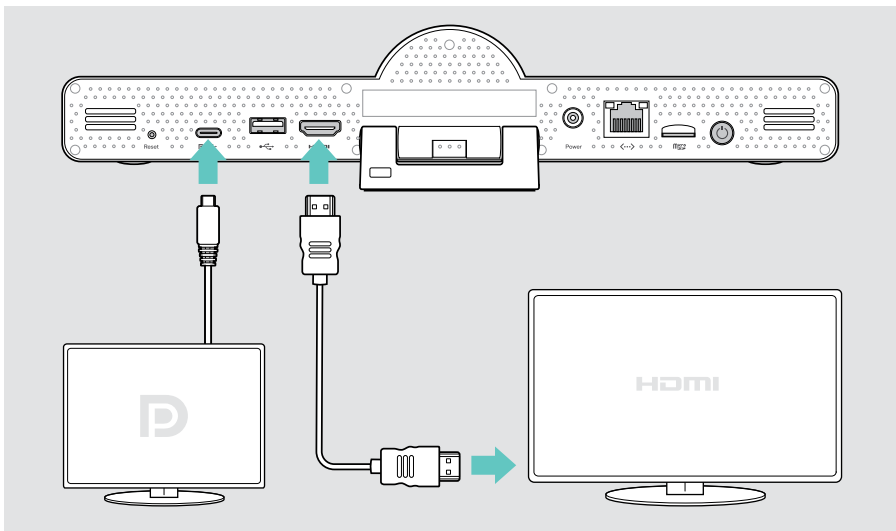

2 Connecting to a network

The collaboration bar requires internet access. You can connect it to a network via:



Wi-Fi:

- > Connect to your Wi-Fi.

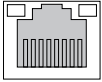

Ethernet:

- > Connect a LAN cable to the Ethernet port.

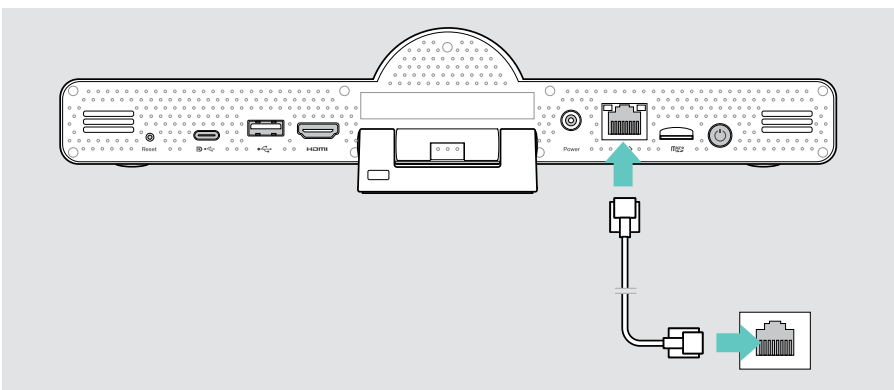

Connecting to Wi-Fi

After the collaboration bar and your screen are turned on:

- > Enter the **Settings** menu > **Device Settings** > **Wi-Fi** to configure your Wi-Fi connection (Password by default: 0000).

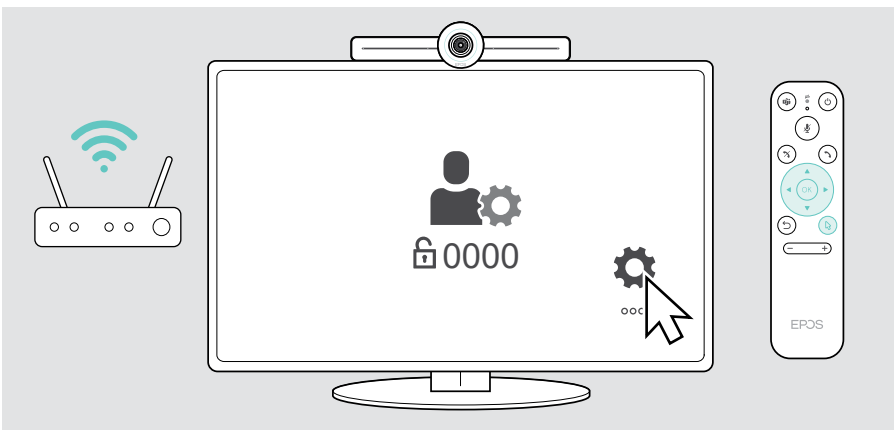

3 Connecting the speakerphone

You can connect the speakerphone either via USB-A or USB-C.



USB-A / USB-C:

- > Release the USB-C plug, unwind the cable and place the speakerphone on your desk.
- > Connect it to USB-C or USB-A via the included adapter. Use the USB extension cable – if required.

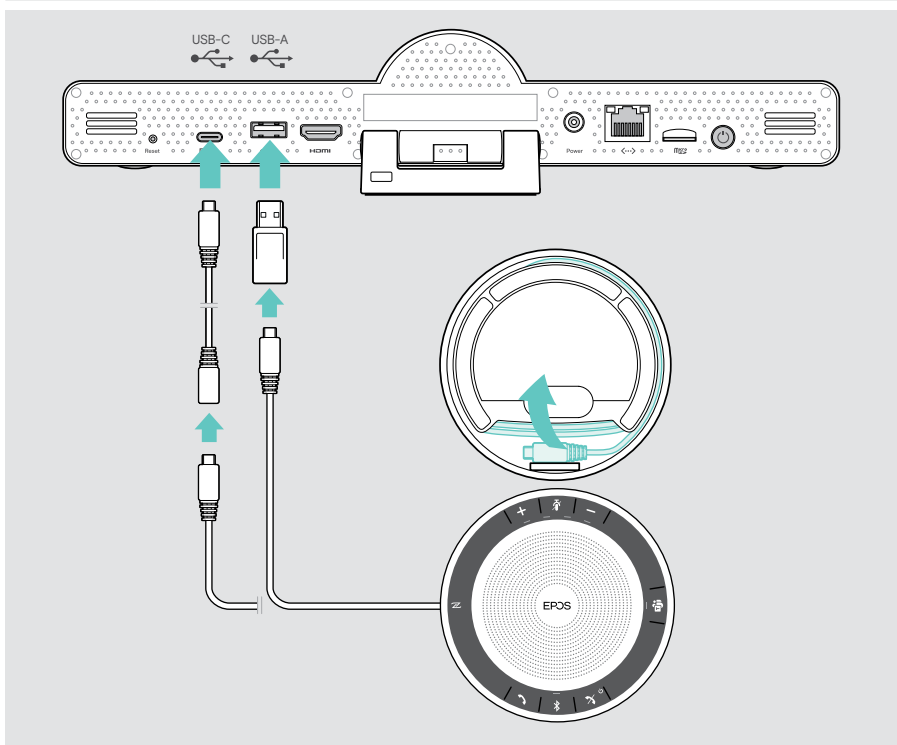

The speakerphone will automatically be charged.

4 Connecting to the power supply



Power

- > Select a suitable country adapter (EU, US, AU, UK) and slide it in.
- > Connect the Power supply unit with the **Power** and wall socket. The collaboration bar turns on. The LED ring lights up mint.

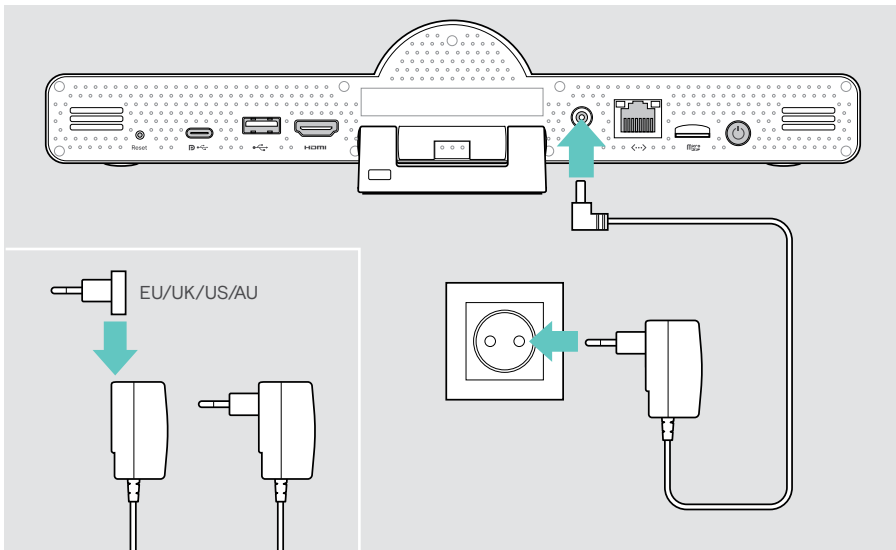

5 Inserting the remote batteries

- > Open the battery compartment.
- > Insert the AAA Alkaline batteries. Take care of the + and - direction.
- > Close the battery compartment.

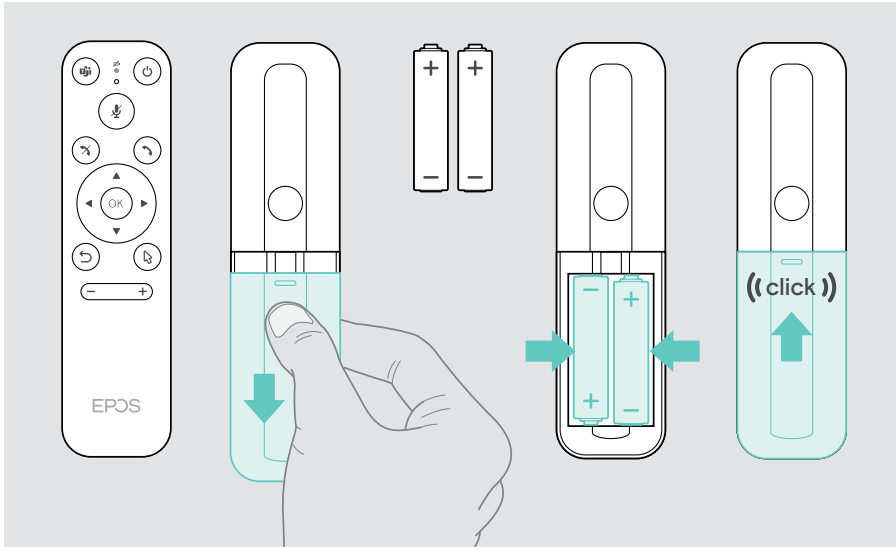

Instead of the remote control you can also use a mouse or your touchscreen.

Pairing Bluetooth devices

The collaboration bar complies with the Bluetooth 5.0 standard. The following Bluetooth profiles are supported: A2DP, HSP and AVRCP.



- Keyboard / Mouse
- Audio Device

> Enter the [Settings](#) menu > [Device Settings](#) > [User Settings](#) > [Bluetooth](#) to connect your Bluetooth device.

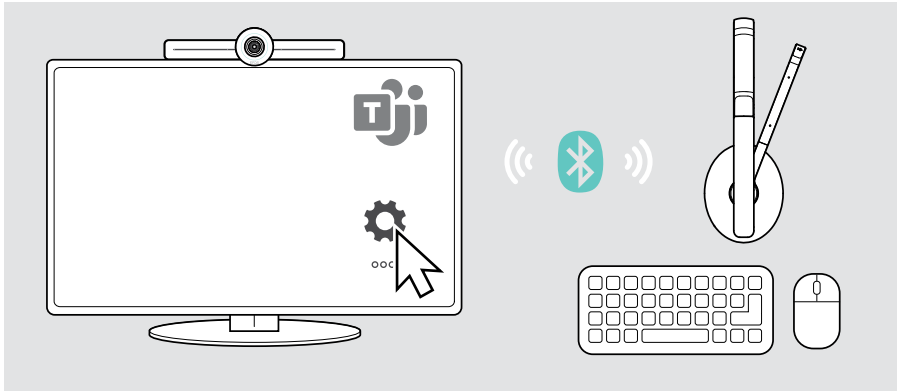

Connecting other accessories

You can connect several other accessories, e.g. for navigation.



USB-A / USB-C:



- > Connect your wired USB device (audio device, keyboard, mouse, touch screen interface).



Micro SD:



- > Insert a micro SD card for internal storage expansion.

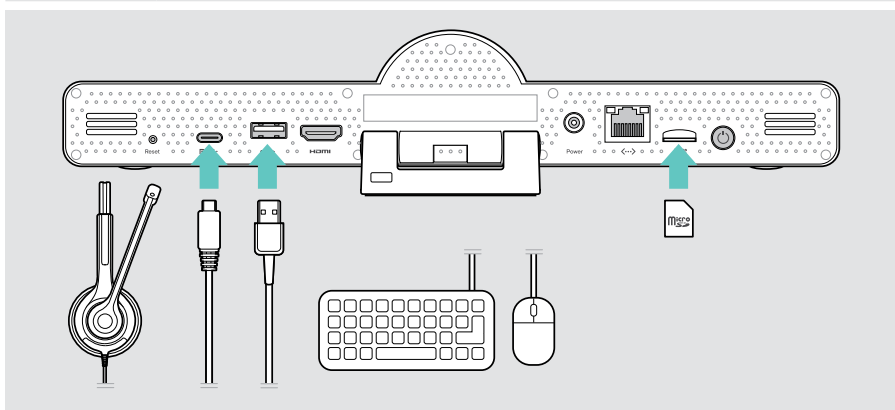

Using EXPAND Vision 3T in USB-mode (BYOD)

If you want to work with a UC provider other than Microsoft Teams:

- > Use your laptop and the EXPAND Vision 3T as a USB device for meetings.
- > Manage the meeting via your laptop instead of the EXPAND Control or remote control.



USB-C:

- > Connect a USB cable from the laptop to the USB-C socket of the EXPAND Vision 3T.

- > Connect a HDMI cable from the laptop to your screen.

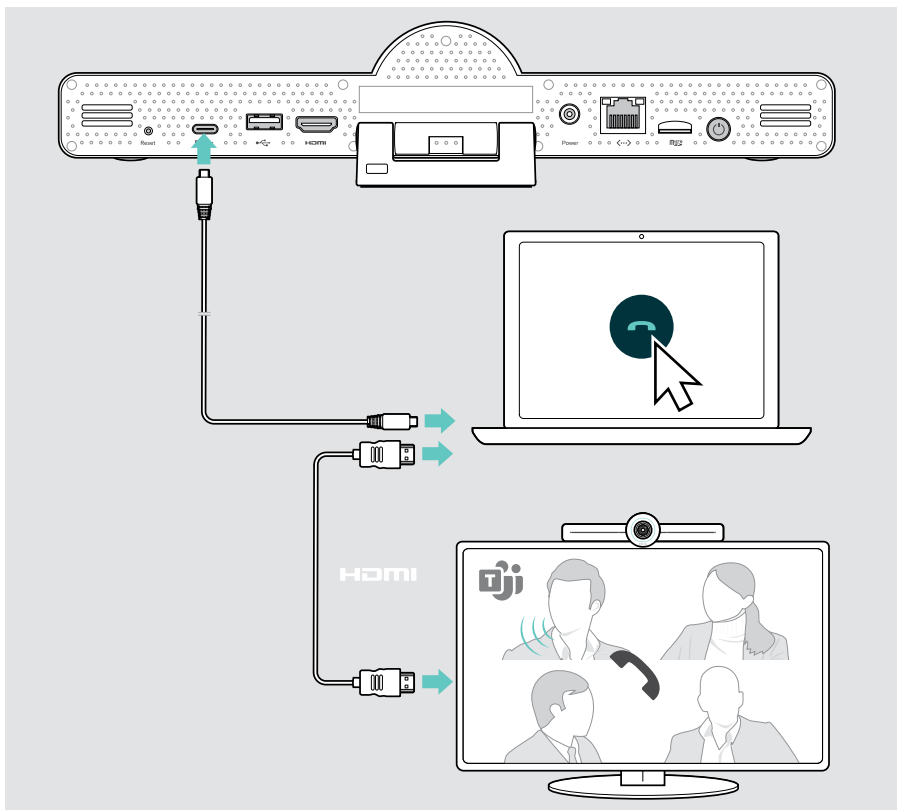

Positioning the devices

You can use the speakerphone in meeting rooms with up to 8 participants.

- > Place the speakerphone as centered as possible.
- > Place the collaboration bar so that it captures meeting participants.

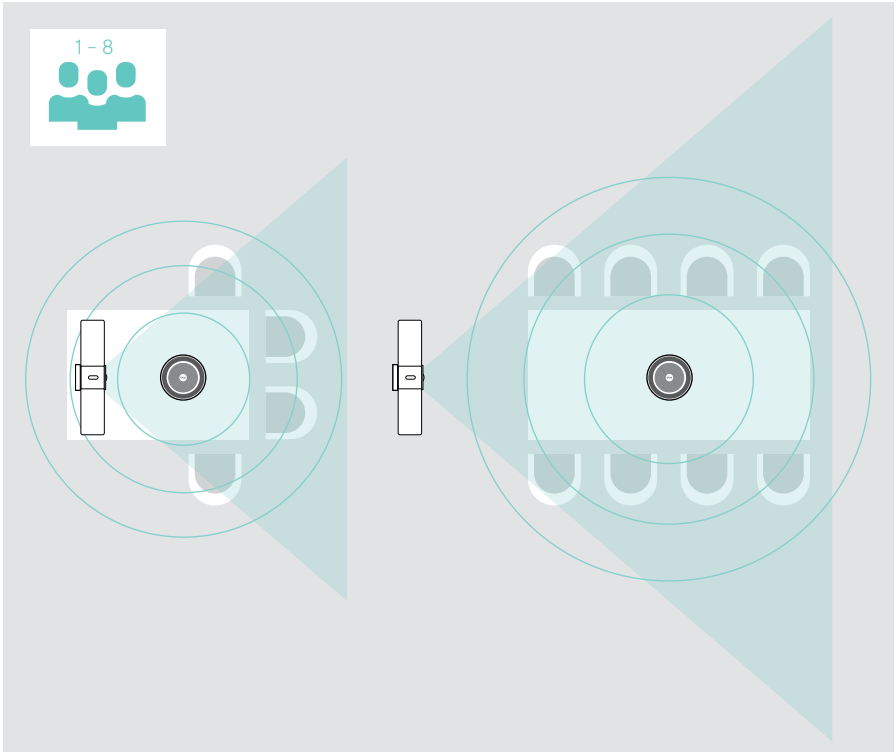

How to use – the basics



The **collaboration bar** turns on automatically as soon as it is connected to power. The LED lights up mint. If it lights up light red, the device is in standby mode (see page 26). The connected speakerphone also turns on and the LED lights up white.

Adjusting the camera

Using the Intelligent Framing feature

The collaboration bar is equipped with an intelligent framing feature - powered by EPOS AI™. This feature automatically frames the picture and adjusts the digital zoom to effectively capture the meeting participants.

- > Enter the **Settings** menu > **Device Settings** > **Other Settings** > **Camera controls** to activate it.

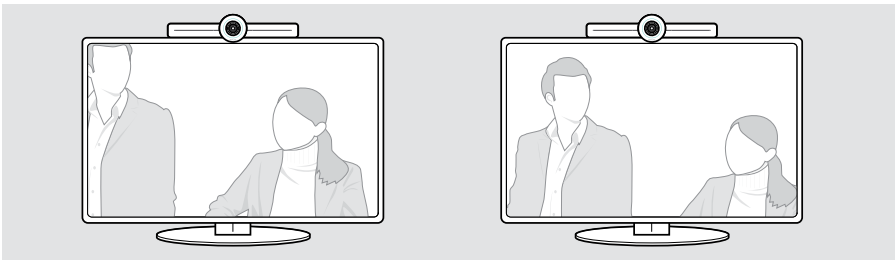

Using the Camera Pan-Tilt-Zoom (PTZ) feature

You can adjust the camera position and digital zoom level to optimally capture the meeting space.

- > Enter the **Settings** menu > **Device Settings** > **Other Settings** > **Camera controls** to adjust it.

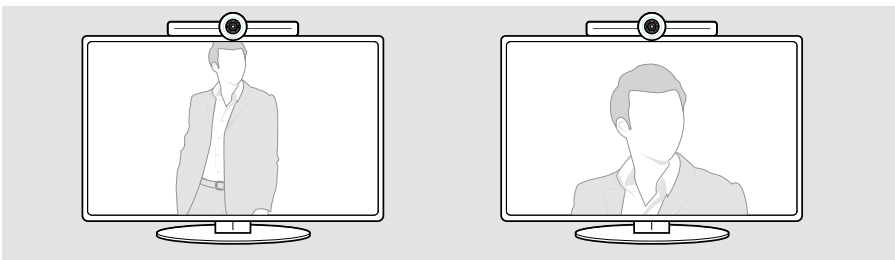

Changing the volume



CAUTION

Risk of hearing damage!

Listening at high volume levels for long periods can lead to permanent hearing defects.

- > Do not continuously expose yourself to high volumes.

You can adjust the volume in a meeting via:

- 1 remote control,
- 2 speakerphone or
- 3 Microsoft Teams on-screen menus

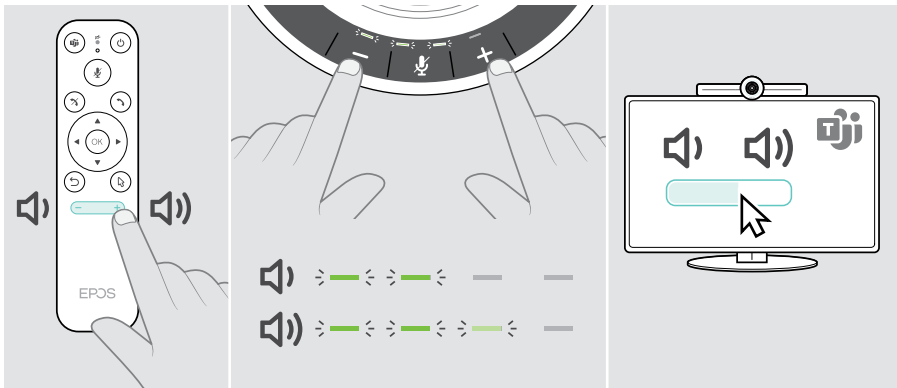

Muting / unmuting the microphone

You can mute or unmute the microphone in a meeting via:

- 1 remote control,
- 2 speakerphone or
- 3 Microsoft Teams on-screen menus

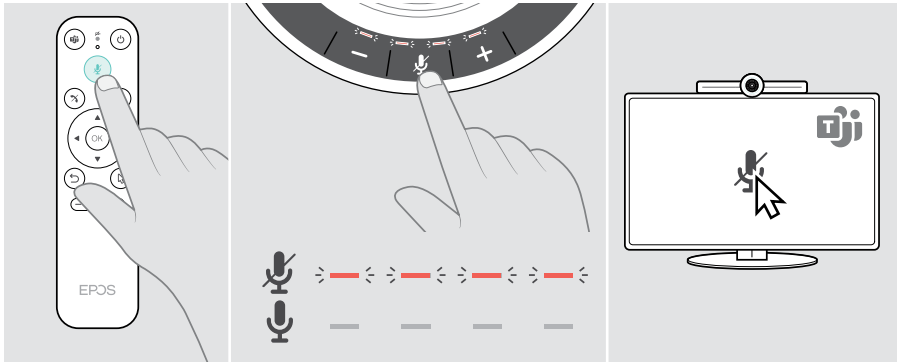

Joining meetings / calls

You can join and control meetings and calls via Microsoft Teams, the remote and the speakerphone (see EXPAND SP 30T User Guide).

- > Join your meeting or initiate a call via the Microsoft Teams on-screen menus. The speakerphone LED lights up green.

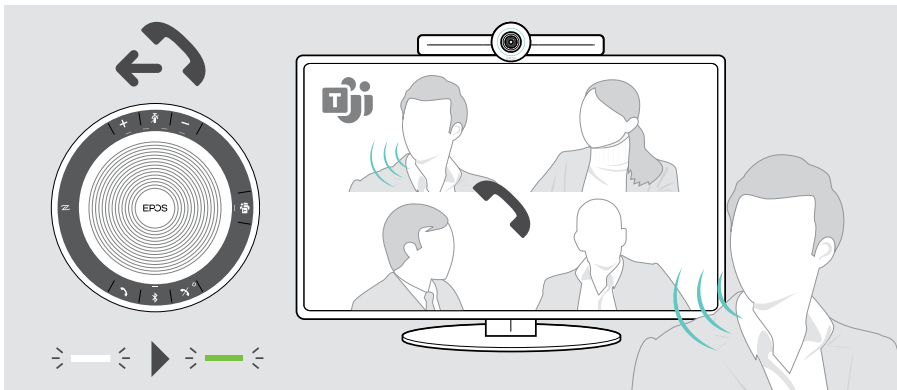

Good to know

Mirroring the screen

You can use Miracast to display content on the connected screen, e.g. by using the “project” function in Windows.



This function is for local content sharing, not for sharing content in Microsoft Teams meetings.

It is possible to change the screencasting name of the device in the settings menu.

Using an optional Kensington® lock

You can secure your collaboration bar e. g. on a table of a meeting room with an optional Kensington lock.

- > Follow the instructions for your Kensington lock.

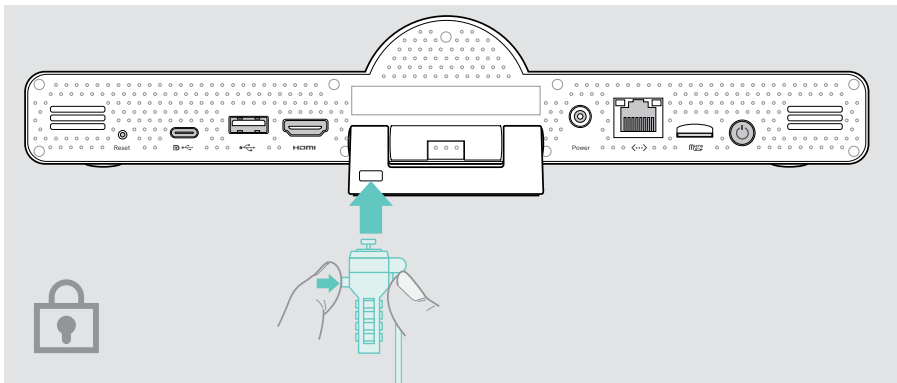

Standby mode & waking up



The collaboration bar turns to standby mode, if:

- you have activated backlight timer in the settings (see page 32) or
- you press the power button on the remote or on the back of the collaboration bar.

The LED ring lights up dimmed red. The speakerphone turns to standby too (activity LED dimmed, all other LEDs off).



To wake up the collaboration bar and the speakerphone:

- > Press any button on the remote control or the power button on the collaboration bar.

The LED ring lights up mint.

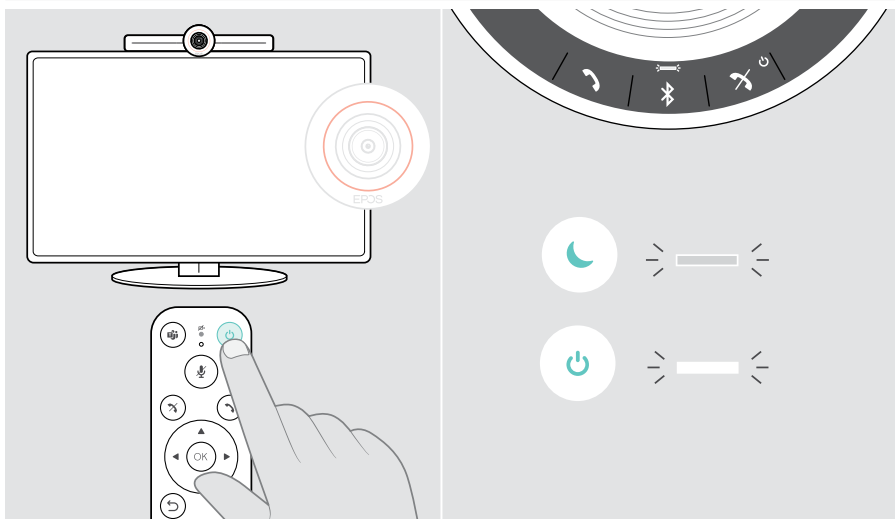

Using the privacy buttons

For additional privacy, the collaboration bar is equipped with hardwired switches for disabling the camera and/or microphones.

- > Press the button on the collaboration bar to activate / deactivate the camera or microphones.

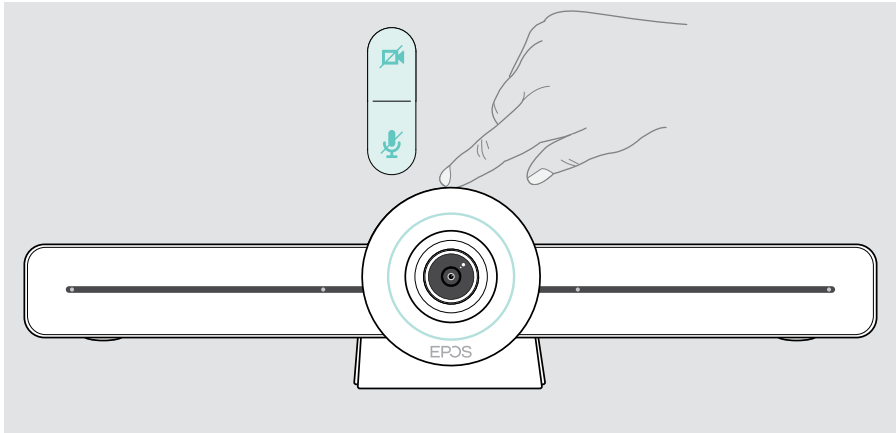

Camera deactivated: Privacy mode

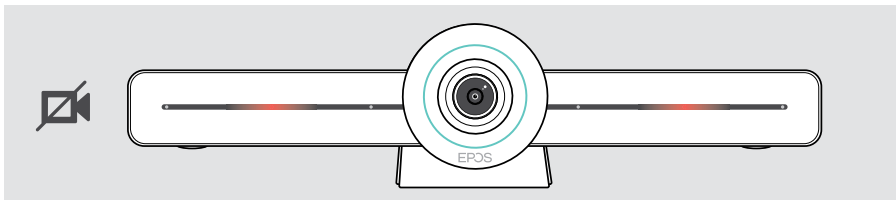

Microphones deactivated: Privacy mode

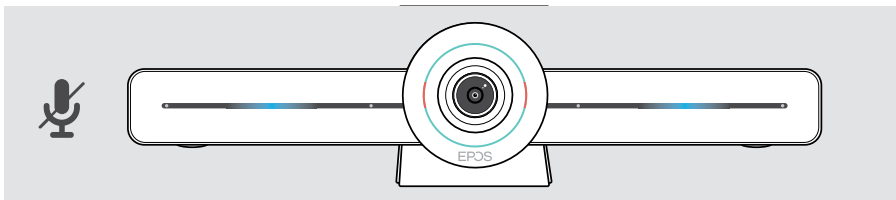

If the privacy mode is activated, the only way to enable it is via the privacy switches.

The switches are intended for additional privacy and not to be used during Microsoft Teams meetings.

Changing EXPAND VISION 3T settings

The on screen settings menu is used for e.g. setting up, configuring and personalizing the device – for example:

- Network and wireless devices connections
- Camera controls
- Display settings
- Language



The Admin settings are password protected – default password: 0000.

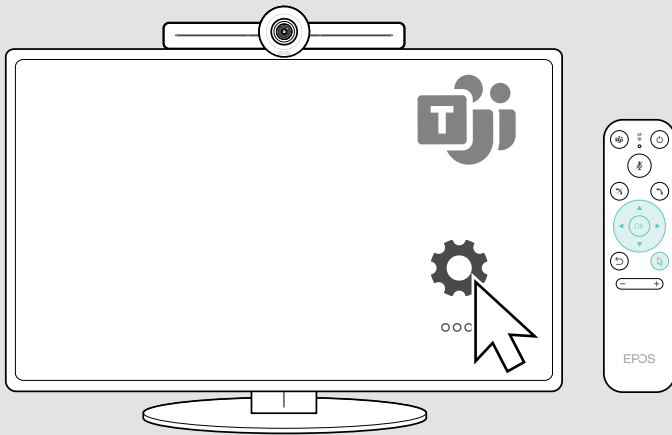

Maintaining & updating products

Cleaning the products

CAUTION

Liquids can damage the electronics of the product!

Liquids entering the housing of the device can cause a short circuit and damage the electronics.

- > Keep all liquids far away from the product.
- > Do not use any cleansing agents or solvents.
- > Use a dry cloth to clean the product only.

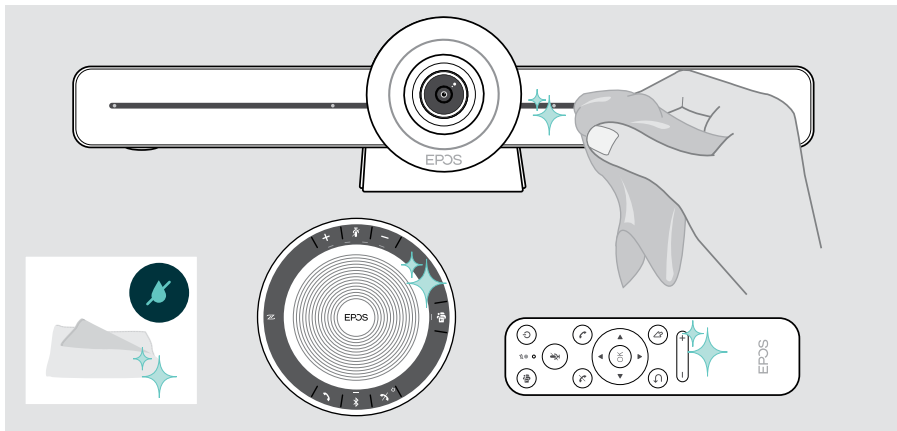

Storing and carrying the speakerphone

Store the speakerphone in a clean and dry environment. When not in use, store the product in the carry pouch. This will help to avoid scratches and keep the product in good condition.

- > Wind up the USB cable and put the speakerphone in the Carry pouch.

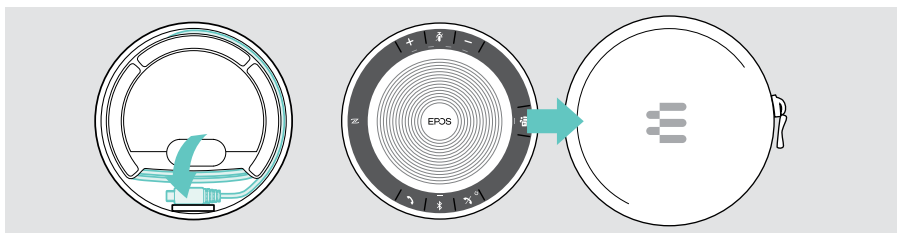

Updating the firmware

Updates for EXPAND VISION 3T will be made available through the Microsoft Teams admin center, and will be downloaded and installed automatically – once enabled by the IT-administrator.

You can update the firmware of your speakerphone by using the free **EPOS Connect** software (see EXPAND SP 30T User Guide).

Replacing / removing the batteries

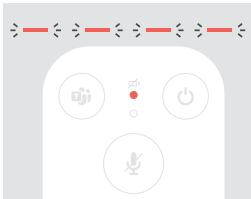

If the remote batteries are almost empty, the remote LED flashes red.

- > Replace or remove the remote control's AAA Alkaline batteries as shown on page 21.

The rechargeable battery of the speakerphone must only be replaced or removed by an authorized EPOS service center.

- > Contact your EPOS service center if the rechargeable battery needs to be replaced. To find an EPOS service partner in your country, visit eposaudio.com.



If you do not use the speakerphone for extended periods of time it is recommended to charge it every 3 months.

If a problem occurs...

If a problem occurs that is not listed here or if the problem cannot be solved with the proposed solutions, please contact your local EPOS partner for assistance. To find an EPOS partner in your country, search at eposaudio.com.

Collaboration bar solutions

Problem	Possible cause	Solution	Page
Microsoft Teams call can not be established	Firewall is blocking the call	> Check and change the network firewall settings based on Microsoft Teams guidelines.	–
Camera image not displayed correctly	Camera position not optimal	> Change the camera positioning and zoom level.	26
Mouse pointer not visible on screen	Mouse pointer disappears after a while	> Press the remote control's arrow button.	–
No audio	Connector not inserted correctly	> Check the cable connection.	15
	Privacy mode for microphone active: collaboration bar front LEDs blue	> Press the mute button on top of the collaboration bar.	31
	Speakerphone is turned off	> Press and hold the Power on/off button for 2 seconds.	–
Low video quality	Poor internet connection	> Check your internet connection performance.	–
	Plastic protection on camera lense not removed	> Remove the plastic protection.	–
No picture on connected screen/monitor or no video captured	Wrong input source selected on connected screen/monitor	> Change input on the screen/monitor.	15
	Cable not connected properly	> Check the cable connection.	15
	Privacy mode for camera active: collaboration bar front LEDs red	> Press the camera button on top of the collaboration bar.	31

Problem	Possible cause	Solution	Page
Remote does not react to any button press	Batteries empty	> Replace the batteries.	21
Collaboration bar does not respond	Collaboration bar has experienced an unexpected error	1 Unplug and plug-in the power supply unit to reboot.	-
		2 Reset the collaboration bar.	36

Restoring factory default settings (hard reset)

- > Unplug the Power supply at the **Power** socket.
- > Press and hold the reset button with e. g. a paper clip.
- > Plug-in the Power supply again.
- > Keep holding the reset button for 10 seconds.
- > Release the reset button.

The collaboration bar factory default settings are restored. The LED lights up and the wizard appears on the screen.

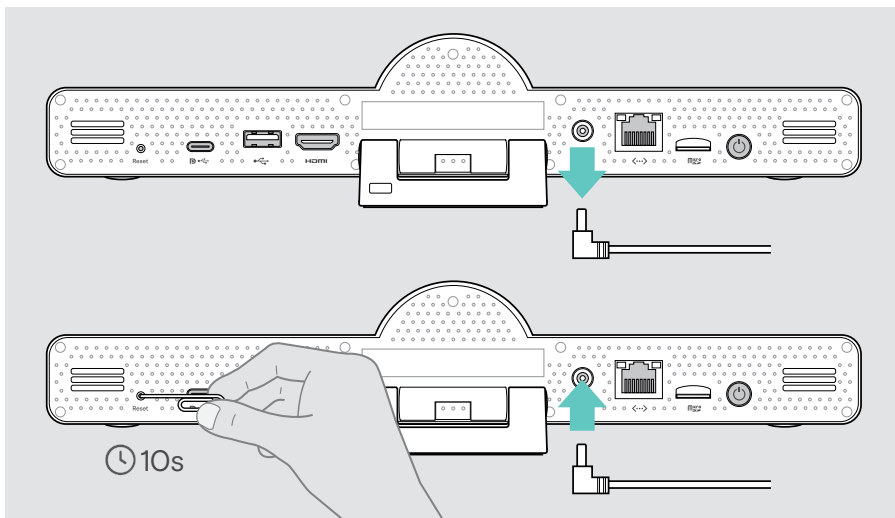

If you release the reset button before the 10 seconds, the developer menu appears on the screen. Repeat the steps above to reset the device.

Speakerphone solutions

Problem	Possible cause	Solution	Page
No audio signal	USB connector not inserted correctly	> Check the connectors and the adapter.	19
	Volume is adjusted too low	> Increase the volume.	27
	Speakerphone is turned off	> Press and hold the Power button for 2 seconds.	–
Activity LED is dimmed and all other LEDs off	Speakerphone in standby mode	> Wake up the collaboration bar.	30
Speakerphone does not react to any button press	Speakerphone has experienced an unexpected error	> Press and hold the Power on/off button for 10 seconds to reboot.	–

For further solutions, check the EXPAND SP 30T User Guide on the product page at [eposaudio.com](https://www.eposaudio.com).

Pairing a new remote

The included remote control is already paired to the collaboration bar. If you have replaced the remote control, you need to pair it.

- > Connect a mouse (see page 23) or use the touchscreen for navigation.
- > Enter the **Settings** menu > **Device Settings** > **Other Settings** > **Unpair remote**.
- > Unplug and plug in the mains power supply, to reboot the collaboration bar.
- > Hold the **BACK** and **OK** button on the new remote simultaneously until the Pairing LED on the remote control flashes red continuously.

As soon as the collaboration bar is re-booted the remote will be automatically paired and the LED on the remote control turns off.

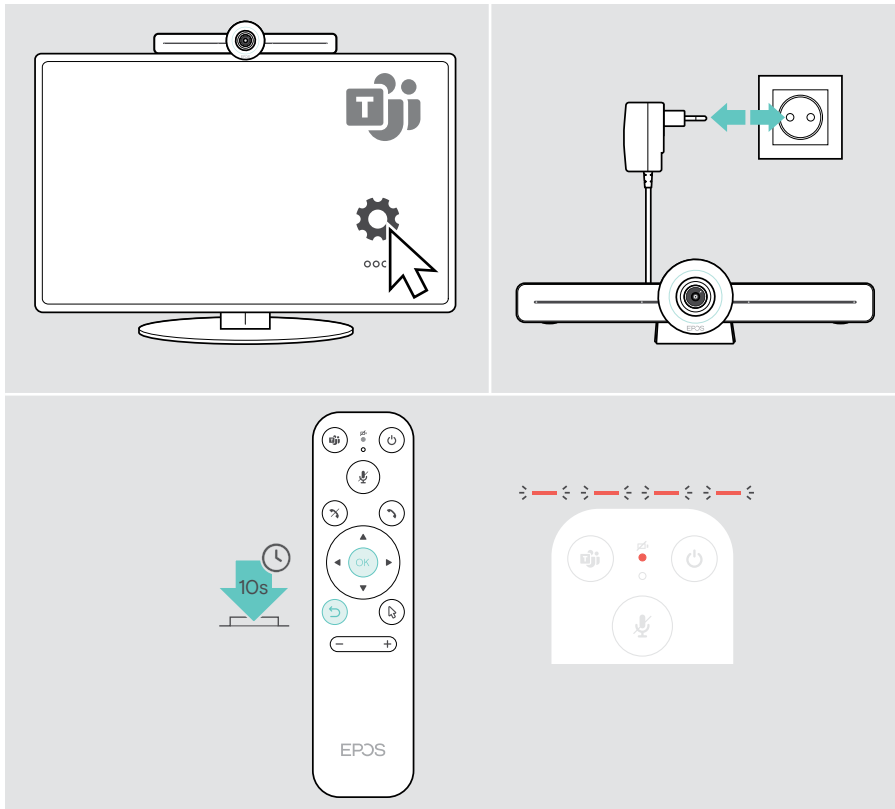

EPOS

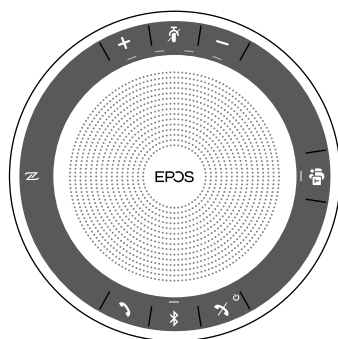
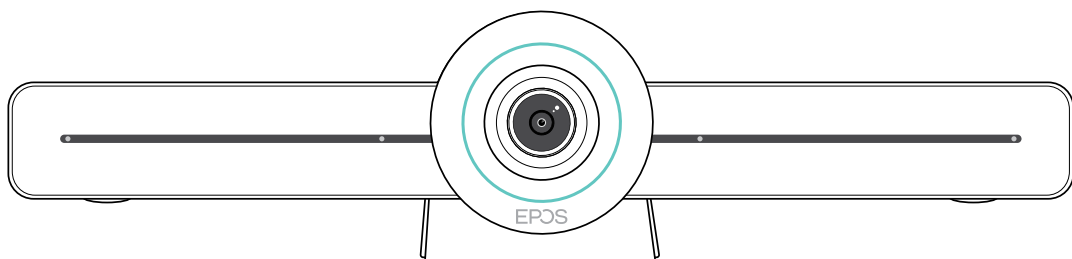

DSEA A/S

Kongebakken 9, DK-2765 Smørum, Denmark
eposaudio.com

Publ. 02/23, A04